

Specification

Measurement

Pressure ranges

Any range from 1 to 360 psi FS available, in any engineering units such as psi, Pa, in H₂O, bar. Absolute or gauge types available

Proof pressure

FS up to 15 psi: 45 psi
 FS > 15 psi up to 360 psi: 3 x FS, (max. 360 psi)
 Consult factory for higher proof pressure

Operating temperature range

-15 to 130°F (process media, Fig. 1)
 -15 to 212°F (process media, Fig. 1)
 -15 to 300°F (process media with cooling ext., Fig. 2)

Compensated temperature range

32 to 160°F (standard)
 -15 to 185°F (option)
 -40 to 185°F (option)

Temperature effects

±1.5% total for 32 to 160°F, > 30 psi FS
 ±2% total for 32 to 160°F, 7 to 30 psi FS
 ±2% total for -10 to 185°F, > 30 psi FS
 ±2.5% total for -10 to 185°F, 7 to 30 psi FS
 Prorated for ranges below 7 psi

Performance

Accuracy

Combined linearity, hysteresis, repeatability, Zero and Span set.
 ≤ ±0.1% FS (≥ 7 psi FS)
 ≤ ±0.25% FS (< 7 psi FS)

Long term stability

0.1% FS/yr for pressure ranges > 30 psi FS
 Prorated for ranges below 30 psi FS
 Under standard conditions

Specification continued

Supply voltage

10 - 30 VDC
 Influence of supply voltage < 0.1% FS

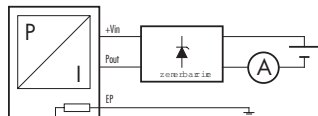

Load resistance

Influence of load resistance < 0.1% FS

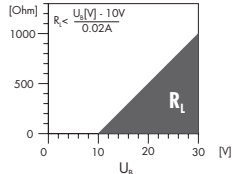

Output signal

4 - 20 mA (2-wire)
 4 - 20 mA with surge (lighting) protection (option)

Insulation resistance

> 50 megohms @ 500 VDC (@ 68°F)

Response time

< 1ms/10 to 90% FS

Construction

Pressure media compatibility
 Stainless steel 316L, Viton seals
 Other seal materials available

Pressure connection

Tri-clamp 1", 1½"
 Other connections available

Electrical connection

DIN 43650 (Fig. 3)
 6-pin bayonet per MIL-C-26482 (10-6) (Fig. 4)
 Polyurethane cable (Fig. 5)
 Demountable versions and other types available

Specification continued

Intrinsically safe

SEV 11 ATEX 0142 X
 EEx 1G ia IIC T3 - T6
 FM/FM-C, Class 1, Div. 1 approved

Weight

9 oz approximate (not including cable)

Vibration

10 g, 10 to 2000 Hz

Mechanical shock

100 g / 6 ms

Ordering information

Please specify the following:

- 1) Model number - ATM/F/IS 85
- 2) Electrical connection
 01 - DIN 43650
 06 - 6 pin bayonet (mating connector extra)
 17 - Polyurethane cable (blue)
- 3) Pressure range, including eng. units, type
- 4) Accuracy
- 5) Output signal
- 6) Any special feature: i.e. lightning protection

Example ordering format:

ATM/F/IS 85 - 17 - 100 psig - 0.1% - 4 - 20mA - 10 feet cable

Options

STS offers a wide range of options for these and other similar transmitters. Please consult the factory for any special requirements.

Examples include:

- Alternate electrical configurations (not IS) i.e. 1 to 5 VDC, 0 to 10 VDC, 0 to 20 mA, RS485
- Special oil filling for food application etc.
- Wide range of pressure connectors
- Wide range of electrical connectors

Dimensions (inches)

Version for medium temperature up to 212°F

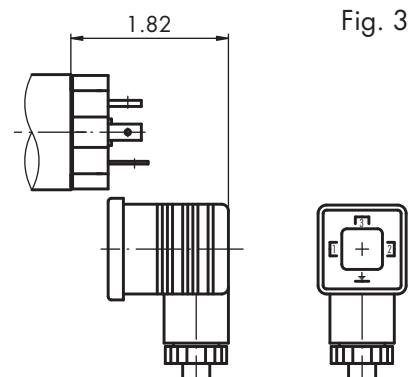
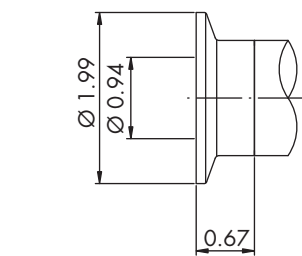
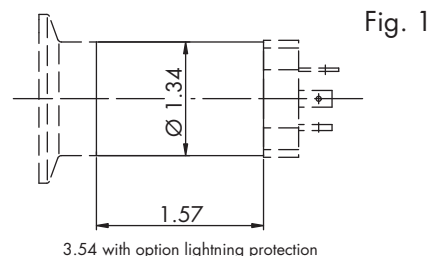

Version for medium temperature up to 300°F

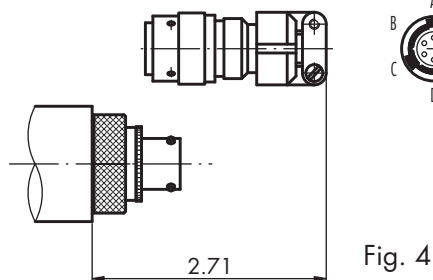
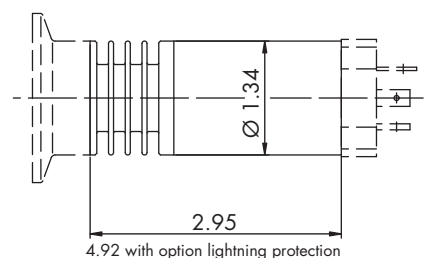

Fig. 5

Specifications may change without notice.

Fig. 2

STS is registered ISO 9001-2008

10.00.0229B - 402



PMC-STs, Inc.
 11 Old Sugar Hollow Road
 Danbury, CT 06810 U.S.A

Tel: 203-792-8686
 Fax: 203-743-2051
 sales@pmc1.com
 www.pmc1.com

Represented by: